

LASER EVOLUTION RGB











General Instructions



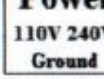

Unpacking:

Thank you for purchasing this product. Please read user guide for safety and operations information before using the product. Keep this manual for future reference. This product can create perfect light programs and effects since it has passed a series of strictly tests before delivery. Please check the attachments listed on the page after opening the carton. Immediately upon receiving a fixture, carefully unpack the box. Check the box contents to ensure that all parts are present and that they are in good condition. If any part appears damaged from shipping, or if the box shows signs of mishandling, notify the shipper immediately. In addition, retain the box and all the packing material for inspection. In any event, save the carton and all packing material because, in case that you have to return the fixture to the factory, you will have to do so in its original box, with its original packing.

What is included: 1* Light, 1*Power Cable, 1*User Guide

Safety Notice: Please read the following notes carefully because they include important safety information about the installation, usage and maintenance of this product. It is important to read all these notes before starting to work with this product.

	There are no user serviceable parts inside the light. Any reference to servicing this unit you may find from now on in this User Manual will only apply to properly C we certified technicians. Do not open the housing or attempt any repairs unless you are one of them.
	Please refer to all applicable local codes and regulations for proper installation of the light.
	Keep this manual for future consultation. If you sell the light to another user, make sure that they also receive this manual.
	Avoid direct eye exposure to the light source while the fixture is on. Always disconnect the light from its power source before servicing. Always connect the light to a grounded circuit to avoid the risk of electrocution.
	This product is for indoor use only! Use only in dry locations. Keep this device away from rain and moisture, excessive heat, humidity and dust. Do not allow contact with water or any other fluids, or metallic objects.
	Make sure there are no flammable materials close to the fixture(s) while operating.
	Please prevent this light away from electrical shock
	When hanging this fixture, always secure it to a fastening device using a safety cable (not provided).
	Always make sure that you are connecting the light to the proper voltage, as per the specifications in this manual or on the product's sticker. Never connect the light to a dimmer pack. Make sure that the power cable is not cracked, crimped or damaged. Never disconnect the fixture by pulling or tugging on the power cable.
	The maximum ambient temperature (Ta) is 104 F (40 C). Do not operate the fixture at a higher temperature. In case of a serious operating problem, stop using this product immediately!
	Use cleaning tissue to remove the dust absorbed on the external lenses periodically to optimize light output.

	Always replace with the exact same type fuse, replacement with anything other than the specified fuse can cause fire or electric shock and damage your unit, and will void your manufactures warranty.
	Do not remove or break the warranty label, otherwise it void the warranty.
	There are no serviceable parts in the LED light. Please have all servicing and adjustments made by a qualified service engineer.
	Don't throw this product away just as general trash, please dispose of this product following the abandon electronic product regulation in your country.
	To protect the environment, recycle packing material wherever possible.

Cleaning

Fixture Cleaning: Due to fog residue, smoke, and dust cleaning the internal and external lenses should be carried out periodically to optimize light output.

1. Use normal glass cleaner and a soft cloth to wipe down the out- side casing.
2. Clean the external optics with glass cleaner and a soft cloth every 20 days.
3. Always be sure to dry all parts completely before plugging the unit back in. Cleaning frequency depends on the environment in which the fixture operates (I.e. smoke, fog residue, dust, dew). In heavy use we recommend cleaning on a monthly basis. Periodic cleaning will ensure longevity, and crisp beam output.

Laser Expected Lifespan

Laser gradually decline in brightness over time. HEAT is the dominant factor that leads to the acceleration of this decline. Packaged in clusters, Laser exhibit higher operating temperatures than in ideal or singular optimum conditions. For this reason when all color Laser are used at their fullest intensity, life of the Laser is significantly reduced. It is estimated that a viable lifespan of 5,000 to 10,000 hours will be achieved under normal operational conditions. If improving on this lifespan expectancy is of a higher priority, place care in providing for lower operational temperatures. This may include climatic-environmental and the reduction of overall projection intensity.

Lasers can be hazardous and have unique safety considerations. Permanent eye injury and blindness is possible if lasers are used incorrectly. Pay close attention to each safety REMARK and WARNING statement in the user manual. Read all instructions careful.

Laser Safety Warnings

Potential laser injury hazard exists with this product! Read these Instructions carefully, which include important information about installation, safe use and service!

Caution:

- *Avoid direct eye contact with laser light. Never intentionally expose your eyes or others to direct laser radiation.
- *This laser product can potentially cause instant eye injury or blindness if laser light directly strikes the eyes.
- *It is illegal and dangerous to shine this laser into audience areas, where the audience or other personnel could get direct laser beams or bright reflections into their eyes.
- *It is a US Federal offense to shine any laser at aircraft.

NON-INTERLOCKED HOUSING WARNING

*This unit contains high power laser devices internally. Do not open the laser housing, due to potential exposure to unsafe levels of laser radiation. The laser power levels accessible if the unit is opened can cause instant blindness, skin burns and fires.

Installation

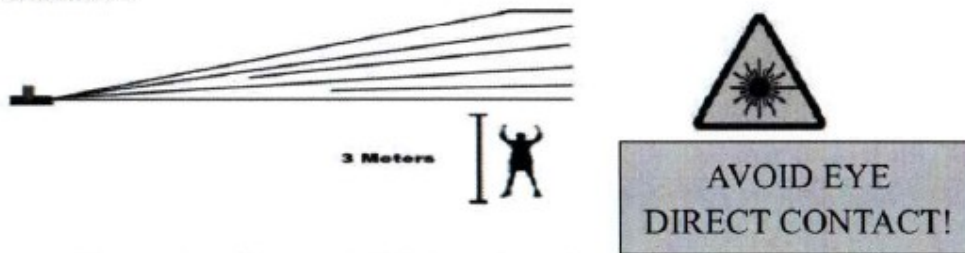

*Laser effects projected 3 meters (9.8 ft) above the audience are eye safe. A survey should be taken to assess the likelihood of any reflective surfaces (such as high windows, chrome bars etc) bouncing stray beams back down into the audience.

*Using a fastening clamps on the light and tight to the ceiling in a strong hook..

*Make sure its correct power output and plug the power cable to the wall socket.

* Power must be in earth! Power on the light.

* Do not shoot the beams to the audience!

*Do not look direct into the laser aperture once the laser light is ON. Please pay attention to the Laser Danger Warning Label!

Caution

After setting up, and before public use, test laser to ensure proper function. Do not use if any defect is detected. Do not use if laser emits only one or two laser beams rather than dozens/ hundreds, as this could indicate damage to the diffraction grating optic, and could allow emission of higher laser levels above Class 3B.

Do not point lasers at people or animals. Never look into the laser aperture or laser beams.

Do not point lasers in areas in which people can potentially get exposed, such as uncontrolled balconies, etc.

Do not point lasers at highly reflective surfaces, such as windows, mirrors and shiny metal. Even laser reflections can be hazardous.

Never point a laser at aircraft, this is a federal offense.

Never point un-terminated laser beams into the sky.

Do not expose the output optic (aperture) to cleaning chemicals.

Do not use laser if the laser appears to be emitting only one or two beams.

Do not use the laser if the housing is damaged, the housing is open, or if the optics appear damaged in any way.

Never open the laser housing. The high laser power levels inside of the protective housing can start fires, burn skin and will cause instant eye injury.

Never leave this device running unattended.

**During Assembly, operation, maintenance, please pay special attention to avoid possible exposure to laser and collateral radiation in excess of the accessible emission limits.*

**Use of controls or adjustments or performance of procedures other than those specified herein may result in hazardous radiation exposure.*

**Protective eye wear is typically required where direct viewing of a Class 3B laser beam may occur.*



The projector must be installed in a location with adequate distance.

Function & Setting

Sound Active

The change of the LED pattern is controlled by sound, that is, the rhythm of the sound control the effect of the changing light pattern.

AUTO

Auto cycles the built-in programs without being controlled externally. It has no light OFF.

Stand-Alone Operation (Sound Active, AUTO mode)

The mode allows a single unit to react to the beat of the music in the master mode.

1. Install the units in a suitable position (laying or appending).
2. Set dipswitch to select Sound Active or AUTO mode.
3. Turn on the unit power, the unit begins reset, then the unit begins working.
4. The unit will react to the low frequencies of music via the internal microphone. Adjust the audio sensitivity knob on the back of the unit to make the unit more or less sensitive in sound active. The panel has LED indicating for sound active.

Master-Slave Operation

This mode will allow you to link up to 32 units together without controller.

1. Install the units in a suitable position (laying or appending).
2. Choose a unit to function as Master mode, set dipswitch to select Sound Active or AUTO mode. The others must be set to Slave mode, set dipswitch to select Slave mode.
3. Use standard XLR microphone cable chain your units together via the XLR connector on the rear of the units. For longer cable runs we suggest a terminator at the last fixture.

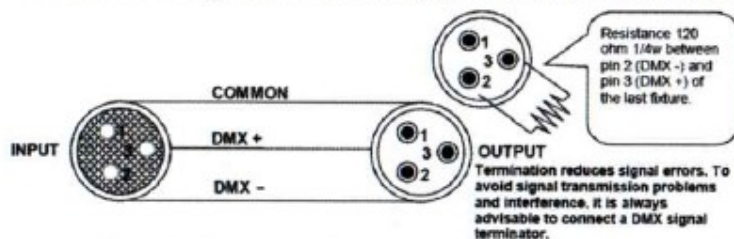

Caution: Do not allow contact between the common and the fixture's chassis ground. Grounding the common can cause a ground loop, and your fixture may perform erratically. Test cables with an ohm meter to verify correct polarity and to make sure the pins are not grounded or shorted to the shield or each other.

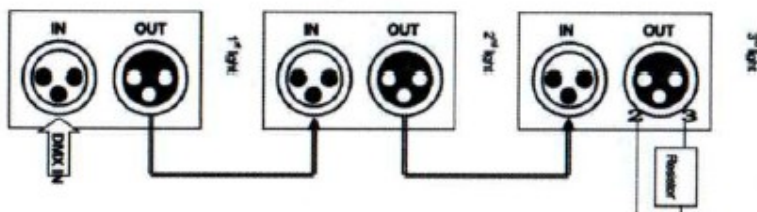

4. Turn on the all units' power, the units begins reset, and then the unit begins working. The slave units will re-act the same as the master unit.
5. The units will react to the low frequencies of music via the internal microphone. Adjust the audio sensitivity knob on the back of the master unit to make the unit more or less sensitive in sound active. The panel has LED indicating for sound active.

Universal DMX Operation (DMX mode)

The system only accepts the DMX512 signal of international standard to control the system. This mode allows you to use universal DMX-512 console to operate.

1. Install the units in a suitable position (laying or appending).
2. Use standard XLR microphone cable chain your units together via the XLR connector on the rear of the units. For longer cable runs we suggest a terminator at the last fixture.
3. Turn on the all units' power, the units begins reset, and then the unit begins working.
4. Use DMX console to control your units.

Notes:

1. DMX console can not be used in Master-Slave operation (Sound Active or AUTO mode).
2. There should be only one master unit in Master-Slave operation.

DMX Control

The system only accepts the DMX512 signal of international standard to control the system mode, the laser beam ON /OFF, running direction, running speed and twinkle speed etc.

Function setting

If it is set to ILDA mode (use PC software to control laser light), just need to connect ILDA signal to DB25 jack. If set to Built-in program, then ILDA signal cannot be connected, setting dipswitches directly is ok. ILDA mode (PC control) and Built-in program mode can be identified and transited automatically.

PC Control Operation

This mode allows you to use PC software(for example: Pangolin, Phoenix, Mamba) to operate. If no IDLA signal to DB25 jack in ILDA mode, the laser and scanner will is closed for protection. The scan speed of software control must be less than the scanner speed, otherwise, the patterns possible have distortion, or the scanner is protected possibly by built-in circuitry.

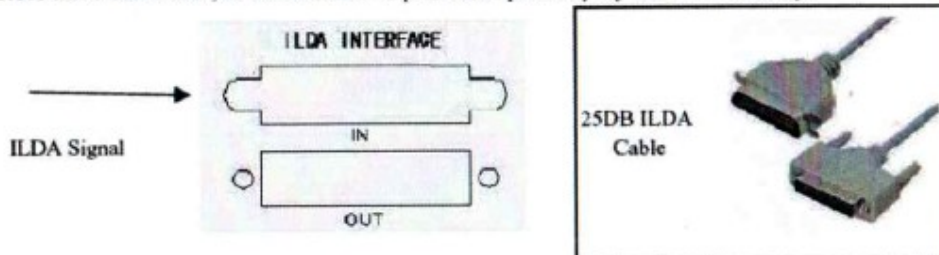

DMX Control

The system only accepts the DMX512 signal of international standard to control the system.

DMX Control Parameter Chart

Channel	Function	Value	Description
1	Mode	0---63	Close, laser OFF
		64---127	Sound active
		128---191	AUTO
		192-255	DMX

Channel	Function	Value	Description
2	Pattern	0----127	Geometric animations
		128---255	Cartoon Animation
3	Red laser brightness	0----3	Brightest
		4----131	Dark to Bright
		132----191	AUTO brightness +
		192---255	Sections brightness +
4	Green laser brightness	0----3	Brightest
		4----131	Dark to Bright
		132----191	AUTO brightness +
		192---255	Sections brightness +
5	Blue laser brightness	0----3	Brightest
		4----131	Dark to Bright
		132----191	AUTO brightness +
		192---255	Sections brightness +
6	Geometric animations	0----3	OFF
		4----255	96 kinds of static patterns
	Cartoon Animation	0----203	103 kinds of static patterns
		204---206	Screen theme animation
		207--209	Wedding animations 1
		210--212	Wedding fly wing to wing animation
		213---215	Halloween theme animation Pumpkin
		216---218	Halloween theme animation Bat
		219---221	Congratulations theme animation
		222---224	Christmas theme animation
		225---227	Happy birthday theme animation
		228---231	Lightning
		232---234	Dancing
		235---237	Musical Notes
		238---240	Fish big splash
		241---243	Wedding Kiss animations
		244---246	Drum beating animation
		247---249	Hip-Hop dancing
		250---252	snake
		253---255	dog
7	Group 1, color settings	0----127	Blackout--W--R--Y--G--C(GB)--B--P(RB)
		128---143	R-G-B change in random
		144---175	R-G-B-Y-C-P-W flowing
		176---207	Animation all 7 colors AUTO change
		208---255	R-G-B-Y-C-P-W Color AUTO change
8	Group 2, patterns selection	0----63	Blackout
		64---255	96 kinds of Geometric animations

Channel	Function	Value	Description
9	Group 2, color settings	0---127	Blackout--W--R--Y--G--C(GB)--B--P(RB)
		128---143	R-G-B change in random
		144---175	R-G-B-Y-C-P-W flowing
		176---207	Animation all 7 colors AUTO change
		208---255	R-G-B-Y-C-P-W Color AUTO change
10	2 groups animations	0---20	Single animation (group 1)
		21---41	X Mirror Symmetry
		42---62	Y Mirror Symmetry
		63---83	X/Y Mirror Symmetry simultaneously
		84---104	zoom In/Out Mirror Symmetry
		105---125	Only Group 2 patterns left/right moving, group 2 no
		126---146	Only Group 2 patterns zoom in/out, group 2 no
		147---167	Only group 2 patterns rotate, group 2 no
		168---188	Rotation mirror symmetry
		189---209	Group 1 no Y moving, group 2 no X moving
		210---230	Group 1 no X/Y moving, but group 2 X/Y moving
		231---251	Group 1 no Y dimmer, group 2 no X dimmer
		252---255	Group 1 no X moving, group 2 no Y moving
11	Moving-X	0---127	Manual to left/right moving
		128--160	Auto to left moving
		161--192	Auto to right moving
		193--224	Auto to left/right moving
		225--239	Jumping
		240--247	Rhombus shape moving
		248--255	Top left/right moving
12	Moving-Y	0---127	Manual to up/down moving
		128--160	Auto to down moving
		161--192	Auto to up moving
		193--224	Auto up/down moving
		225--231	Circle shape moving
		232--239	Sin shape moving

Channel	Function	Value	Description
12	Moving-Y	240--247	Square shape moving
		248--255	Bottom corner up/down moving
13	X Dimmer	0---127	Dimmer manual
		128--255	Dimmer Auto
14	Y Dimmer	0---127	Dimmer manual
		128--255	Dimmer Auto
15	Rotation	0---127	Manually rotation
		128--159	Auto clockwise rotation
		160---191	Auto counter clockwise rotation
		192---223	clock pendulum effect
		224---255	Ellipse shape rotation
16	Zoom(+/-)	0	no motion
		1---159	Manual zoom(+/-)
		160--191	Auto zoom(+)
		192--223	Auto zoom(-)
		224--255	Auto zoom(-/+)
17	Sine wave fluctuation	0---63	no motion
		64---127	X fluctuation
		128---191	Y fluctuation
		192---255	X/Y fluctuation
18	Fluctuation speed	0---255	Fluctuation speed slow to fast
19	Display Dot	0---64	Manually dot
		65---255	Auto dot slow to fast

LCD Digital Display



MENU: Function mode selection, such as DMX512/Masterslave, AUTO strobe, Sound Active Strobe, Constant light on, brightness adjustment

DOWN/UP: previous or next, increase or decrease

Enter: confirm and save the selection.

LCD0802 digital meanings:

- *add=DMX512 address value 001---512
- *graph_size=graphics size adjustment 0---255
- *scanspeed=scanner speed rates 10KPPS---30KPPS
- *sensitivity=sound sensitivity value 0---100 from low to loud

LCD 0802 Digital Operation Details:

1. Power on the light, then, the light is on reset mode, LCD0802 displays:
Mode and DMX512 address.

Working Modes: Auto、Sound、DMX512、Slave、Dimming.
Address:001---512 value

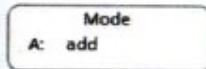

2. Working mode settings:

Auto Mode: automatically working, default as Master unit, sending signals to Slave units
Sound Mode: sensitive running with external music. Default as Master unit, sending signals to Slave units.

DMX512: DMX512 signal control

Slave mode: synchronously working in same program, receiving signals from Master units

Dimming mode: use for manufacturing beam alignment testing or user's installation testing.

*Under the [Work Mode Set], press ENTER to the next menu.

*Press UP/DOWN to select work mode and press ENTER to save the setting. Press Menu back to the previous setting.

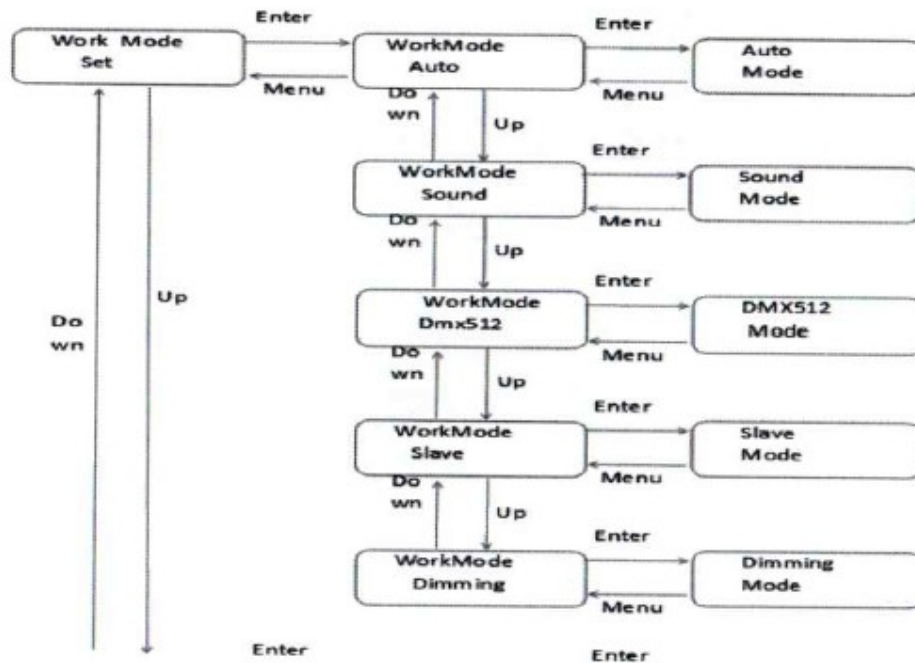

3. DMX512 address setting:

add: 001----512 value

*Under the [Address Set], press ENTER to DMX512 address setting.

*Press UP/DOWN to increase or decrease address value at 1 each time. Press ENTER to save and press Menu back to the previous setting.

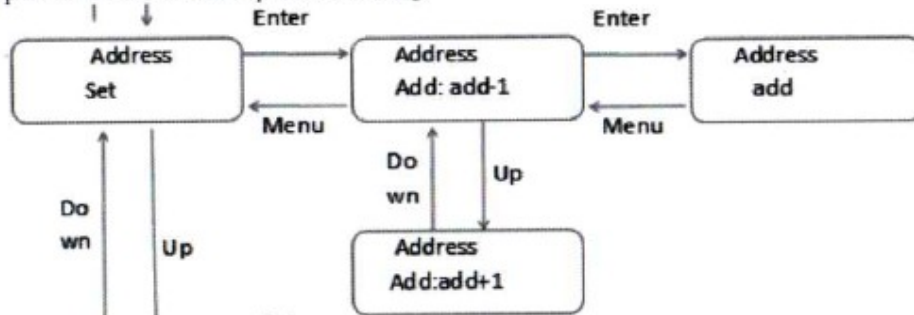

4. Graphics Mode Setting:

*Under the [Graph Mode Set], press ENTER to the next setting.

*Press UP/DOWN to the graphics selections:

(1) Beam Mixed; (2) Sheets; (3) Circles; (4) Waves; (5) Boxes; (6) Points; (7) Cartoon Mixed; (8) KTV; (9) Halloween; (10) Christmas; (11) Wedding; (12) Animals

*Press ENTER to save the setting.

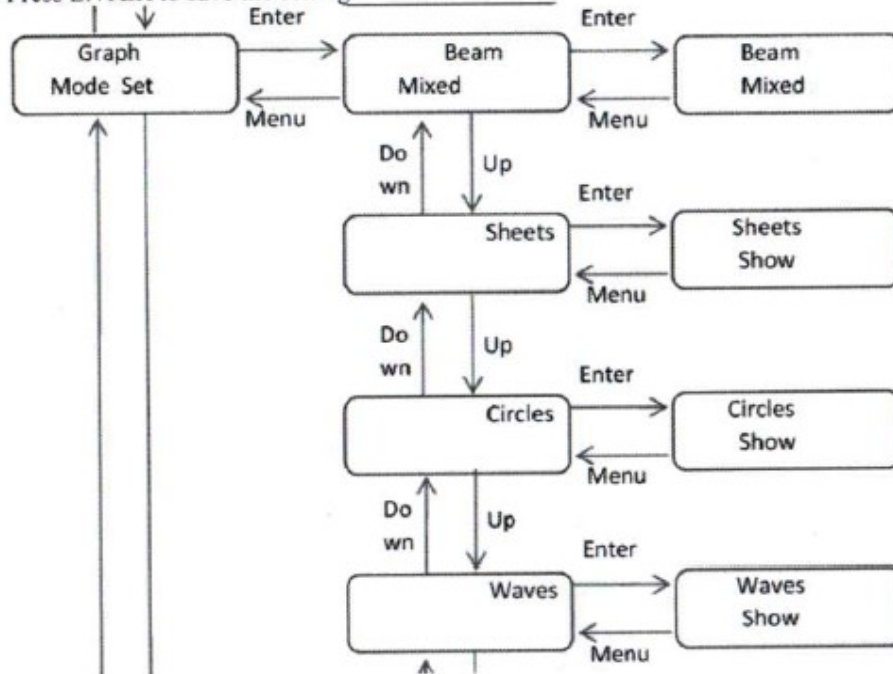

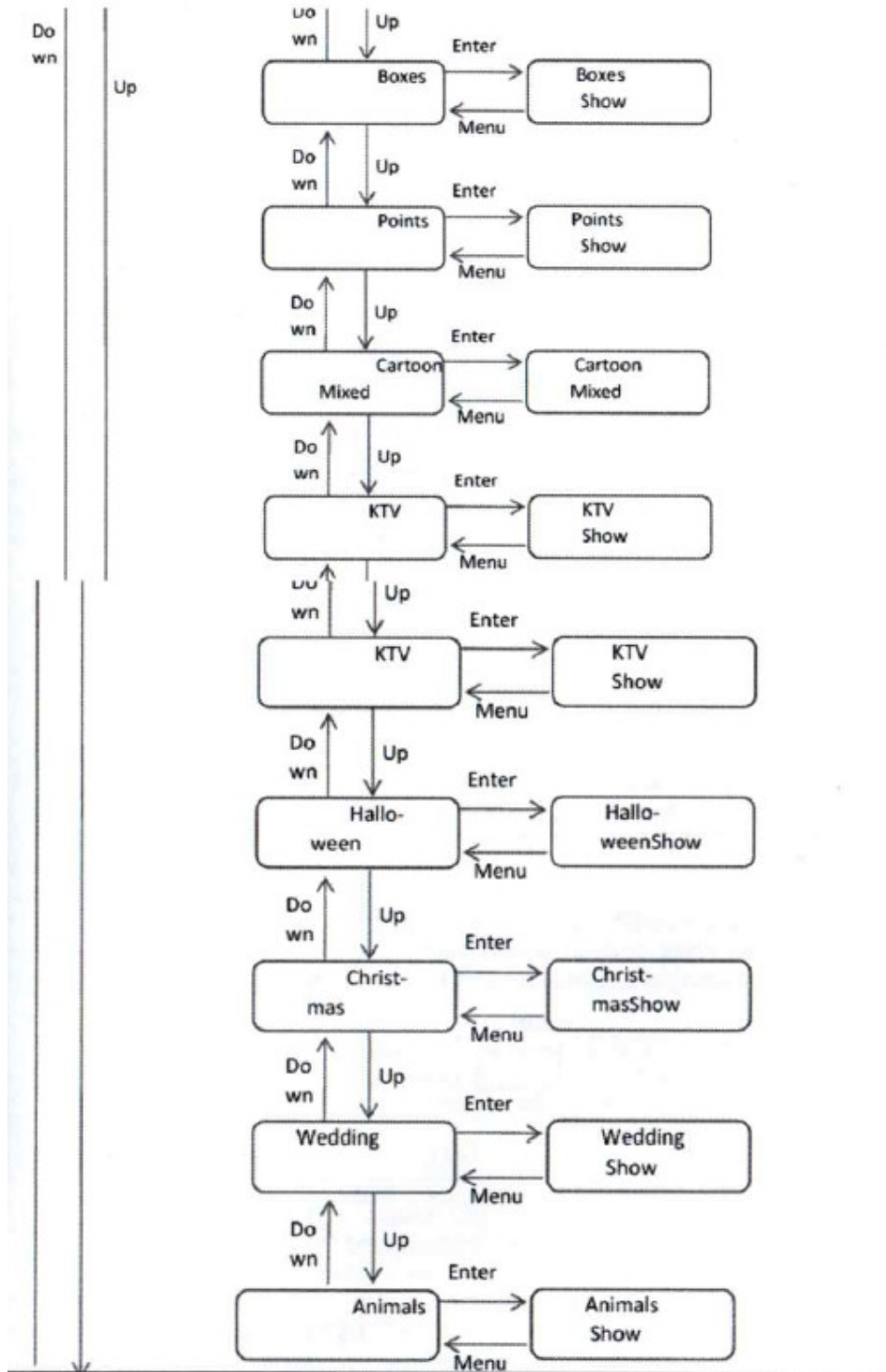

5. Invert Mode Set

*Under [Invert Mode Set], press ENTER to the next setting.

*Press UP/DOWN to select Invert OFF, X Invert, Y Invert, XY Invert, XY Exchange.

*Press ENTER to save the setting and press Menu back to the previous setting.

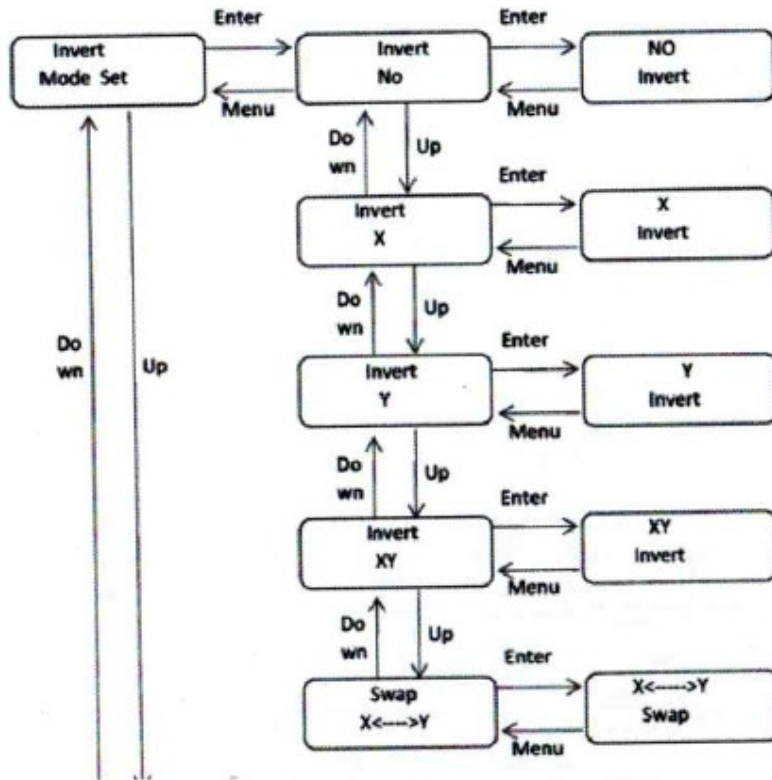

6. Lasers Type Set:

*Under the [Lasers Type Set], press ENTER to the next setting.

*Press UP/DOWN to select single, double, full RGB color.

*Press ENTER to save the setting and press Menu back to the previous setting.

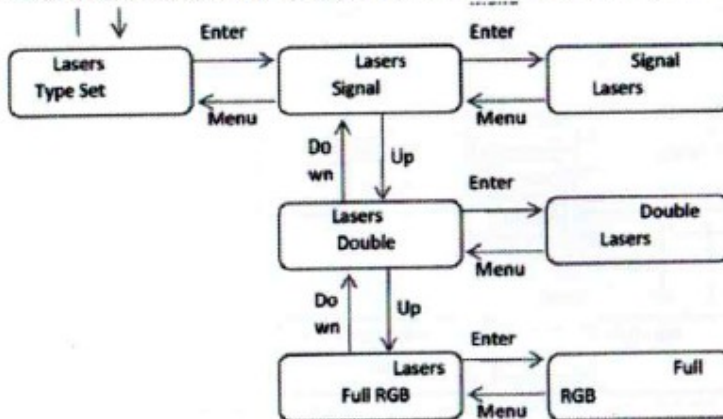

7. Color Type Set:

- *Under [Color Type Set], press ENTER to the next setting.
- *Press UP/DOWN to select Analogue or TTL modulation.
- *Press ENTER to save the setting and press Menu back to the previous setting.

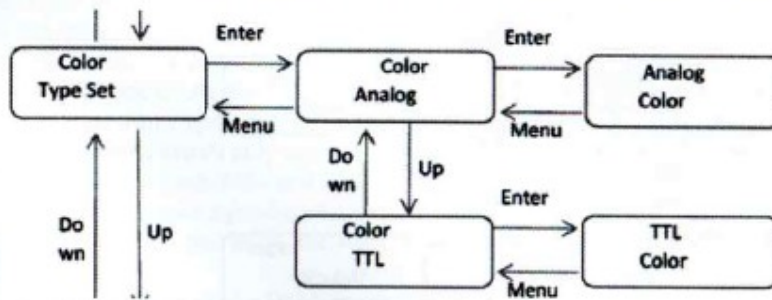

8. Graphic Size Set:

- graph_size:0--255
- *Under [Graph Size Set], press ENTER to the next setting.
- *Press UP/DOWN to set the graphics size at 1 each time.
- *Press ENTER to save the setting and press Menu back to the previous setting.

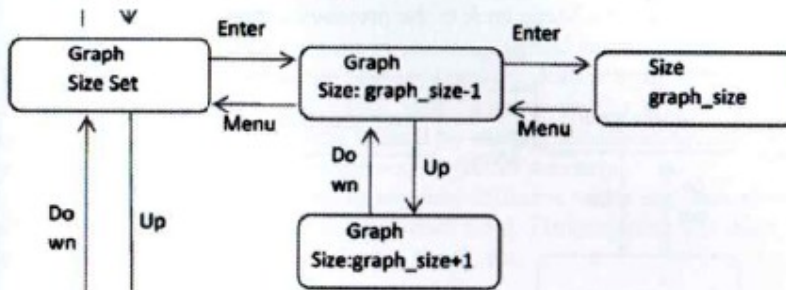

9. Scan Speed Set

- scanspeed:10K--40K
- *Under [Scan Speed Set], press ENTER to the next setting.
- *Press UP/DOWN to increase or decrease scan speed at 1K each time.
- *Press ENTER to save the setting and press Menu back to the previous setting.

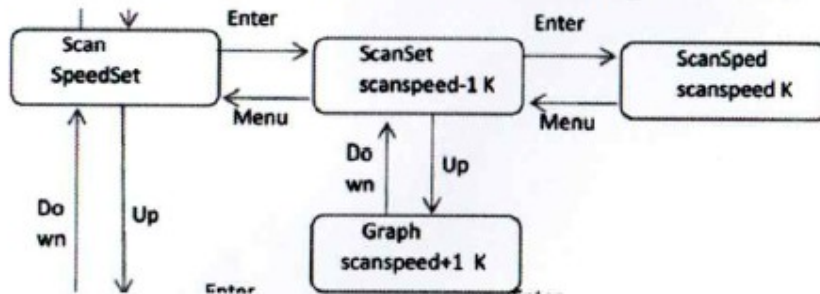

10. Velocity Set

- *Under [Velocity Set], press ENTER to the next setting.
- *Press UP/DOWN to set speed Slow, Medium or Fast.
- *Press ENTER to save the setting and press Menu back to the previous setting.

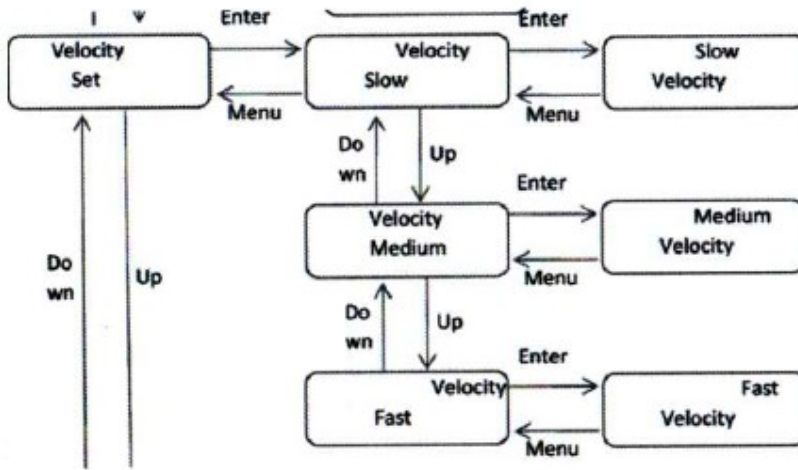

11. Sensitivity Set

sensitivity rate:0---100

*Under [Sensitivity Set], press ENTER to the next setting.

*Press UP/DOWN to increase or decrease sensitivity rate at 1 each time.

*Press ENTER to save the setting and press Menu back to the previous setting.

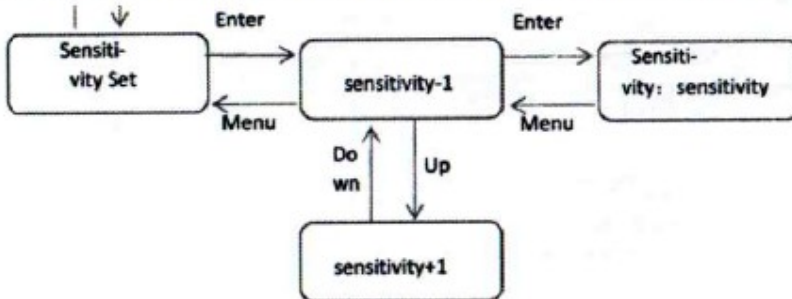

Troubleshooting

1. If the power supply indicator doesn't light up and the light doesn't work, please check the power supply, the input voltage and the fuse.
2. In Stand-Alone operation, if the power supply indicator is light up and sound active indicator isn't light up, but the light is shut off doesn't work.
 - A. Because sound is too small make for light shut off in sound active, please increase the music volume or increase audio sensitivity with sensitivity knob, please check as below.
 - B. Please check if unit has been set up in slave mode, then set up in master mode.
3. In Master-Slave operation, slave unit don't function, please check as below.
 - A. Make sure to there's only one master in the chain, and the others are set in slave mode.
 - B. Make sure to control the unit without DMX console controlling.
 - C. Make sure to take a good quality power cable and connection.
4. In DMX mode operation, the laser is OFF and the DMX signal indicator is unlighted, please check as below.
 - A. Make sure to set up the DMX mode.
 - B. Make sure to have a good connection.
5. In DMX operation, the unit can't be controlled by the DMX console, but the DMX signal indicator is flashing, please make sure the DMX console and unit have the same channel.
6. If the unit is fail, please turn off the unit, then turn on again after 5 minutes.

Warranty Warnings:

1. Damages caused by the disregard of this user manual are not subject to Warranty. The dealer will not accept liability for any resulting defects or problems.
2. Please consider that unauthorized modifications on the device are forbidden due to safety reasons. Please note that damages caused by manual modifications on the device or unauthorized operation by unqualified persons are not subject to warranty.
3. If this device will be operated in any way different to the one described in this manual, it may suffer damages and the guarantee becomes void. Furthermore, any other operation may lead to dangers like short-circuit, burns electric shock, etc.

After trying the above solution you still have a problem, please contact your dealer or our company for service.